

## CHARACTERISTICS

- OPERATES UP TO 300 BAR (4350 PSI)
- DIVIDES OIL OR GREASE
- TOP OR SIDE OUTPUTS AS STANDARD
- SINGLE OR DUAL OUTLET SETTABLE BY CENTRAL PLUG
- FULL RANGE OF PRESSURE AND SPOOL MONITORING ACCESSORIES INTERCHANGEABLE WITH SMO PRODUCT LINE
- THE TWO OUTPUTS ARE COMBINED BY REPLACING THE ADAPTER. JUST TAKE ONE ITEM OF STOCK
- ASSEMBLING SIMPLE AND FLEXIBLE
- BRIGHT LEFT/RIGHT/BOTH ELEMENTS ELIMINATE THE NEED FOR EXTERNAL CROSS PORTING
- DIFFERENT INLET MODULE WITH DIFFERENT HOLE-CENTERS FOR EASY INTERCHANGEABILITY

## METERING DIVIDER ELEMENTS FOR THE VOLUMETRIC DISTRIBUTION OF OILS AND GREASE

Dropsa's **nano-Progressive (nP)** dividers are the ideal solution for grease lubrication applications that require small and accurately dispensed quantity of lubricant in a compact solid and reliable footprint.

Thanks to a patented **RigidLock** novel interlocking mechanism between the elements **it has the rigidity of a mono-block divider but the flexibility of a modular segmented unit.**

The **nP-nano progressive** uses the progressive movement of pistons to allow precise quantities of lubricant to be accurately dispensed to multiple points.

The lubrication cycle can be controlled by a single sensor including the Dropsa solid state Ultrasensor product.

These metering elements may be used in a variety of system configurations and have different working configurations that make them flexible for use in multiple applications.

The compactness makes them particularly suitable for use in confined spaces.

These metering elements may be used in a variety of system configurations and have different working configurations that make them flexible for use in multiple applications.



## OPERATING PRINCIPLE

The system can be easily extended and the modular concept provides low cost replacement of component.

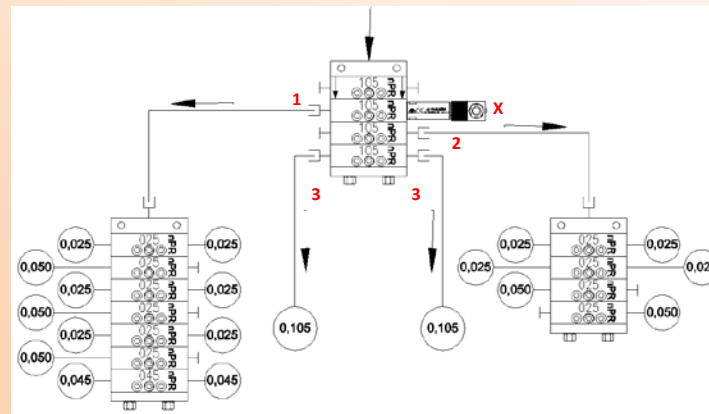

The **nP105** metering element (1) pilots a block of 6 metering 0,025 nP delivering elements and one 0,045 nPr.

The **nP105** metering element (2) pilots a block of 4 0,025 nP delivering elements.

The **nP105** metering element (3) directly lubricates two point of the machine.

The cycle is controlled by the Ultrasensor cycle indicator (X).

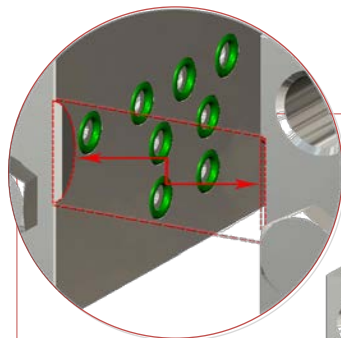

## RIGIDLOCK

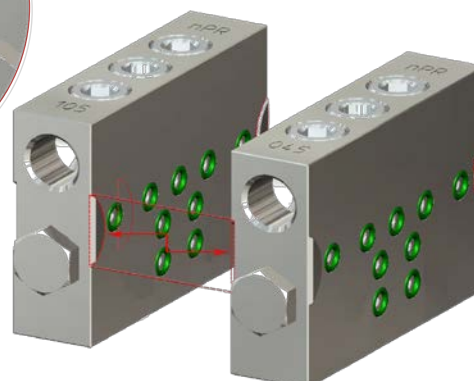

THE RIGIDLOCK SYSTEMS CREATES A RIGID INTERLOCKING MECHANISM BETWEEN THE ELEMENTS VIRTUALLY ELIMINATING LEAKS TYPICALLY FOUND ON PREVIOUS SEGMENTED ELEMENTS CAUSED BY TORSION OR TENSION IN THE TUBING

## APPLICATION

- MACHINE TOOLS
- TEXTILES
- ANY SMALL-MEDIUM OIL AND GREASE SYSTEMS

## ADVANTAGES

- By combining a reduced space-envelope and maintaining modularity in a single package the **nano-Progressive** dividers offer many of the features found in top-of-line dividers at a fraction of the cost.
- The **RigidLock Systems** creates a rigid interlocking mechanisms between the elements virtually eliminating leaks typically found on previous segmented elements caused by torsion or tension in the tubing
- A full range of accessories and bridge elements allows for flexible engineering choices.

## TECHNICAL INFORMATION

GENERAL CHARACTERISTICS	
Singular outlet Flowrate	0.0015 cu.inch – 0.0027 cu.inch – 0.0045 cu.inch - 0.0064 cu.inch (0,025cm <sup>3</sup> - 0,045cm <sup>3</sup> - 0,075cm <sup>3</sup> - 0,105cm <sup>3</sup> )
Number of Dividers elements	3 ÷ 12
Working pressure	15bar (218psi) ÷ 300bar (4350psi)
Working temperature	-20°C ÷ +80°C
Material	Nickel-plated steel
Number of inversion at minute	200 max ( according to pressure and viscosity)
Inlet thread	1/8" BSP
Outlet thread	1/8" BSP
Lubricants	Min. Oil. 32 cSt –max. 2 NLGI grease

N.B.: The pressure drop is directly proportional to the number of cycles.  
The oil and grease viscosity values always refer to the operating temperature.

## DIMENSIONS

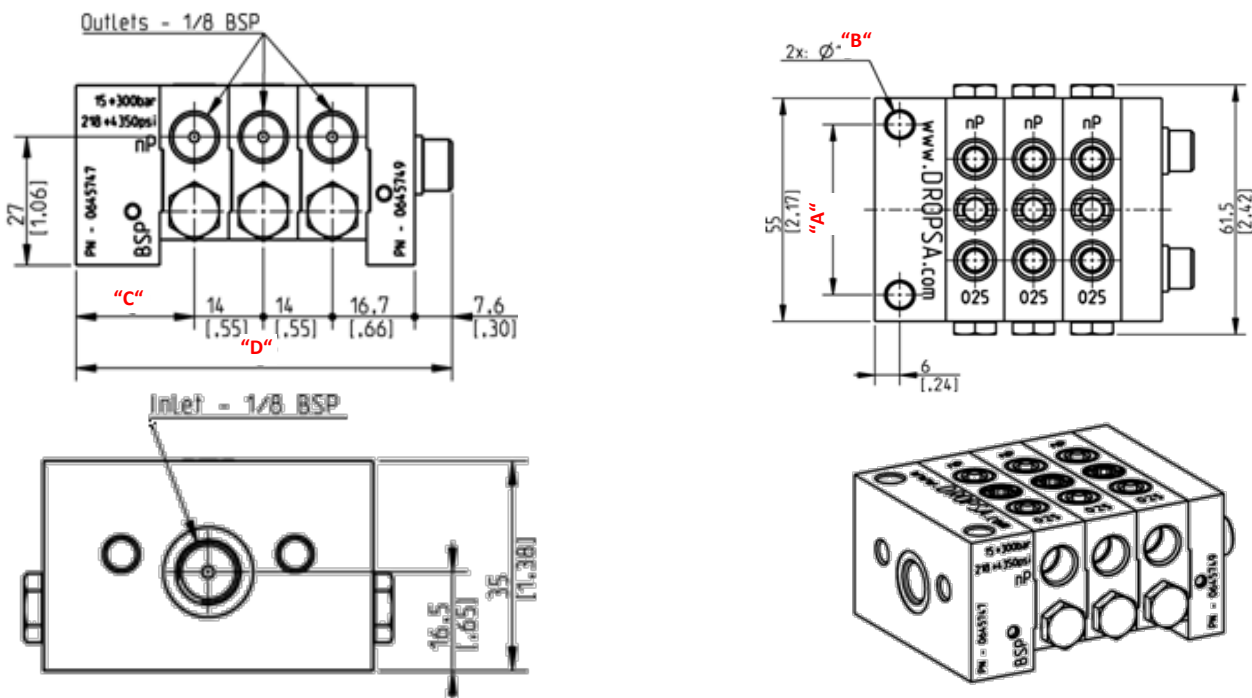

N° elements	INLET nP – standard version mm [inch]				INLET nP-S 20mm reduced hole centers mm [inch]			
	"A"	"B"	"C"	"D"	"A"	"B"	"C"	"D"
3				76.3 [3]				82.8 [3.26]
4				90.3 [3.55]				96.8 [3.82]
5				104.3 [4.11]				110.8 [4.36]
6				118.3 [4.66]				124.8 [4.91]
7	42 [1.65]	6.2 [0.24]	24 [0.94]	132.3 [5.21]	20 [0.79]	5.5 [0.22]	30.5 [1.2]	138.8 [5.46]
8				146.3 [5.76]				152.8 [6.02]
9				160.3 [6.31]				166.8 [6.57]
10				174.3 [6.86]				180.8 [7.12]
11				188.3 [7.41]				194.8 [7.67]
12				202.3 [7.96]				208.8 [8.22]

## CONFIGURATION INFORMATION

IN FEW STEPS YOU CAN COMPOSE DIFFERENT KIND OF MODULES AS YOU NEED:

### 1. INLET ELEMENT

### 2. DIVIDER ELEMENT (REPEAT FOR NUMBER OF ELEMENTS)

### 3. END ELEMENT

STANDARD ELEMENT	-S 20mm reduced	FLOWRATE Q, cm <sup>3</sup>	STANDARD ELEMENT	ELEMENT WITH INDICATOR	BRIDGE ELEMENT			PART NO.
					LEFT	RIGHT	LEFT/RIGHT	
0645747	0645748	0,025	0645750	0645778	0645754	0645758	0645762	0645749 + 0016047 (ø6 washer)
		0,045	0645751	0645779	0645755	0645759	0645763	
		0,075	0645752	0645780	0645756	0645760	0645764	
		0,105	0645753	0645781	0645757	0645761	0645765	

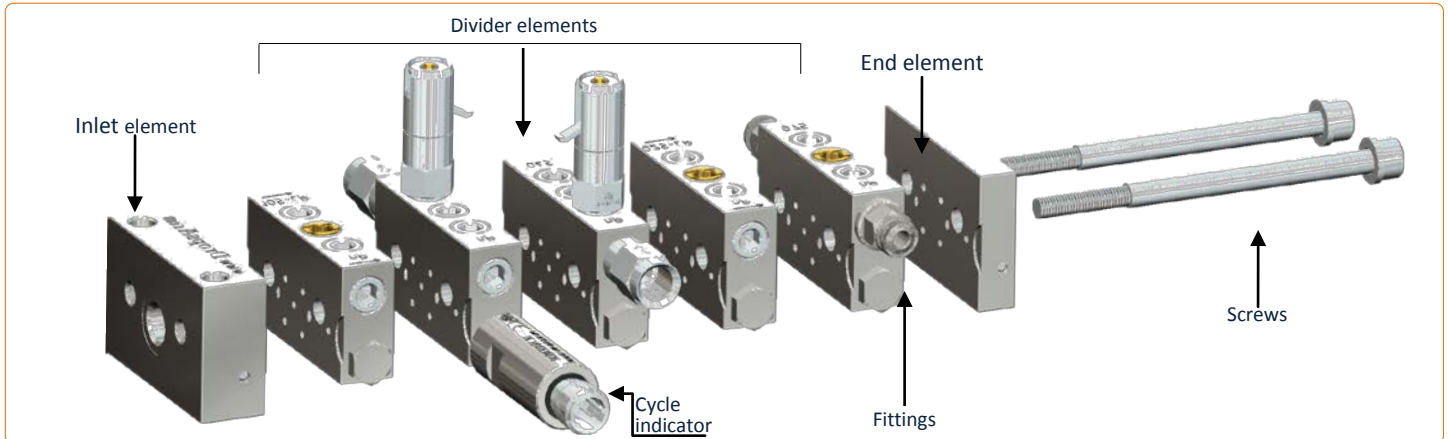

### 4. FITTINGS

ITEM	DESCRIPTION	PART N.
<b>PRESSURE INDICATOR</b>	30bar with memory pin	3290000
	50bar with memory pin	3290001
	75bar with memory pin	3290022
	100bar with memory pin	3290002
	150bar with memory pin	3290003
	200bar with memory pin	3290004
	250bar with memory pin	3290005
	300bar with memory pin	3290021
	20bar with pin	3290019
	30bar with pin	3290006
	50bar with pin	3290007
	100bar with pin	3290008
	150bar with pin	3290009
	200bar with pin	3290010
	250bar with pin	3290011
	30 bar with membrane	3290012
	50 bar with membrane	3290013
100 bar with membrane	3290014	
150 bar with membrane	3290015	
200 bar with membrane	3290016	
250 bar with membrane	3290017	
<b>CYCLE INDICATOR</b>	<b>ULTRASENSOR + (M12 Connector)</b>	<b>1655308 + 0039999</b>

ITEM	DESCRIPTION	PART N.
<b>FITTINGS</b>	1/8" valved fitting for OUTLETS	0092335
	1/8" valved fitting for INLET	0092555
	Ø6 Compression Fittings (150bar)	0092080
	Ø4 Compression Fittings (150bar)	0092069
	Ø4 ring fitting (250bar)	0091942
	Push-in Ø4 (65bar)	3084577
	Push-in Ø6 (65bar)	3084578
	Swivel Push-in 90° Ø6 (150bar)	3084695
	Swivel Push-in 90° Ø4 (150bar)	3084696
	<b>TUBING</b>	Ø6x1 Drawn steel tube (400bar)
Ø4x1 Drawn steel tube (500bar)		5119832
ASTM Ø6x0,71 Copper steel tube (310bar)		5118001
ASTM Ø4x0,71 Copper steel tube (500bar)		5118000
Ø4x0,5 Annealed copper tube (133bar)		5501201
Ø6x1 Annealed copper tube (200bar)		5501203
PA Ø4xØ2,5 Tube (60bar)		5717202
PA Ø6xØ4 Tube (50bar)	5717203	
<b>SCREWS</b> order 2 per assembly	3 elements	0014396
	4 elements	0014181
	5 elements	0014397
	6 elements	0014182
	7 elements	0014191
	8 elements	0014398
	9 elements	0014399
	10 elements	0014400
	11 elements	0014401
	12 elements	0014402

ITEM	DESCRIZIONE	CODICE
WASHER (order 2 per assembly)	Ø6 WASHER	0016047
PLUG and ADAPTOR	Single outlet adaptor	0641708
	Plug 1/8 BSP	3232098

DESCRIPTION	PART N.
Assembly Kit 3 elements	3140826
Assembly Kit 4 elements	3140827
Assembly Kit 5 elements	3140828
Assembly Kit 6 elements	3140829
Assembly Kit 7 elements	3140830
Assembly Kit 8 elements	3140831
Assembly Kit 9 elements	3140832
Assembly Kit 10 elements	3140833
Assembly Kit 11 elements	3140834
Assembly Kit 12 elements	3140835

Each kit includes 2 screws, 2 washers, plugs and single outlet adaptors according to the number of elements.



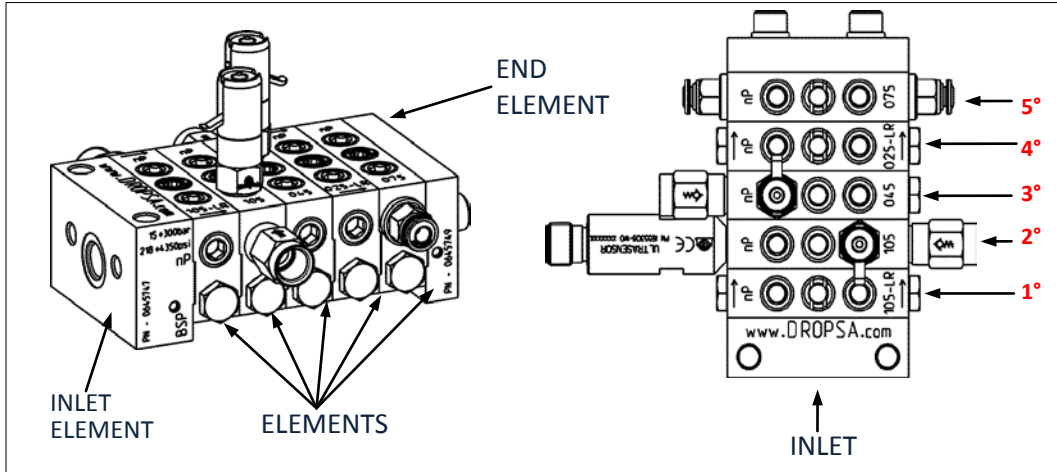

**Note:** to determine the left and right outlets, be noted that the assembly is seen vertically and metering elements are numbered sequentially starting from the bottom (inlet).

Indicate the full string of the package as in the following ordering example:

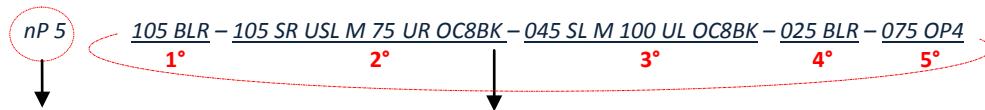

Config. INLET and PACK		
TYPE	INLET	N° ELEMENTS
nP	Empty Standard Hole centers 42mm	3÷12
	S Reduced Hole center 20mm	

ELEMENT configuration (repeat for N° element)						
FLOWRATE [cm³]	OUTLET	CYCLE CONTROL	PRESSURE CONTROL			OUTLET FITTINGS
			TYPE	PRESSURE [bar]	POSITION	
025 0,025	Empty both	US Ultrasensor right side	M with memory rod	30-50-75 100-150-200 250-300	L left	OP4 Ø4 Push-in
045 0,045	SL single left	USL Ultrasensor left side	P with rod	20-30-50 100-150 200-250	R right	OP6 Ø6 Push-in
075 0,075	SR single right	V visual right side	B with membrane	30-50 100-150 200-250	LR left right	OC8BK 1/8" BSP valved
105 0,105	BL bridge left	VL visual left side			UL Single left upper	OC8NK 1/8" NPT valved
	BR bridge right				UR Single right upper	
	BLR bridge left & right				URL Single right & left upper	
	U Both Upper					
	UL Single left upper					
	UR Single right upper					

## SINGLE AND DOUBLE OUTLET CONVERSION

It is possible to double the delivery of a single element by replacing the yellow Adapter Part No. 0641709 with the white Adapter Part No. 0641708 as shown in the drawing below. When converted into single, plug off the second outlet with a plug Part No. 3232098

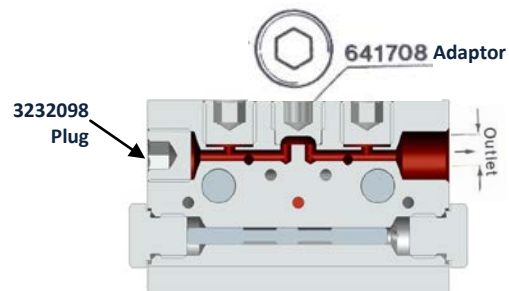
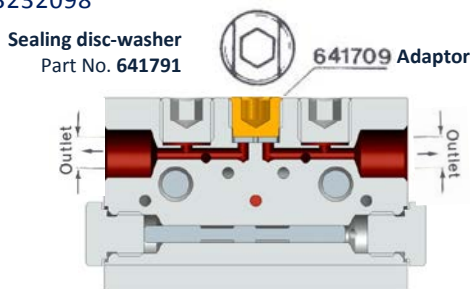

Info Distributor: